

boneli™

boneli™



Cascada sofa

Copyright © 2010 Boneli

designer **Grego**

info@boneli.com | +44 (0)7546.106.926

boneli™



Cascada sofa

Copyright © 2010 Boneli

designer **Grego**

info@boneli.com | +44 (0)7546.106.926

boneli™



Cascada sofa

Copyright © 2010 Boneli

designer **Grego**

info@boneli.com | +44 (0)7546.106.926

boneli™



Cascada sofa

designer **Grego**

Copyright © 2010 Boneli

info@boneli.com | +44 (0)7546.106.926

boneli™



Cascada sofa

designer **Grego**

Fabric

standard color range for the Cascada sofa is Kvadrat Tonica
COM (Customer's Own Materials) option is also available

* removable upholstery on seat and backrest; dry-clean only

Frame

standard finish for the metal frame is chrome-plated steel

standard color range



632 631 612 611 532 531 512 511 412 411 272 231 221 192 182 171 111



Tonica | 111

kvadrat tonica

132 131 962 961 832 831 812 811 792 791 762 732 761 731 751 762 672 671

two-arm module

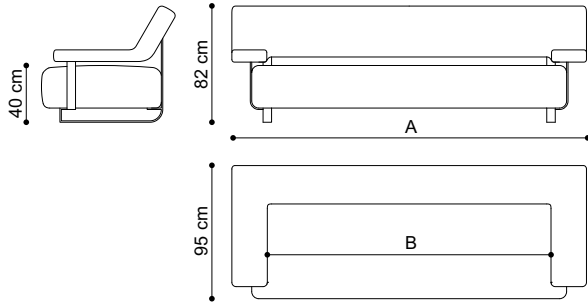

	A	B
3+ seater	250cm	200cm
3 seater	230cm	180cm
2 seater	170cm	120cm
1 seater	110cm	60cm

one-arm module (R)

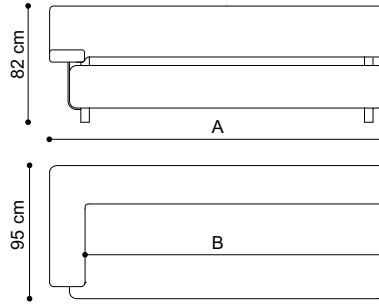

	A	B
3+ seater	236cm	211cm
3 seater	216cm	191cm
2 seater	156cm	131cm
1 seater	96cm	71cm

one-arm module (L)

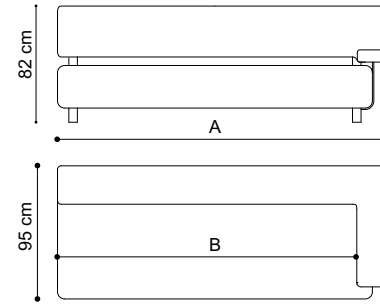

	A	B
3+ seater	236cm	211cm
3 seater	216cm	191cm
2 seater	156cm	131cm
1 seater	96cm	71cm

corner module

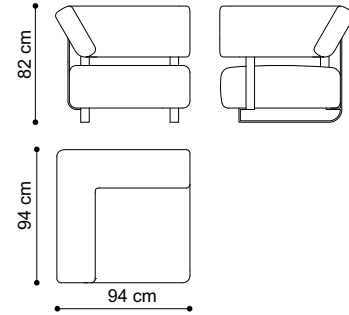

no-arm module

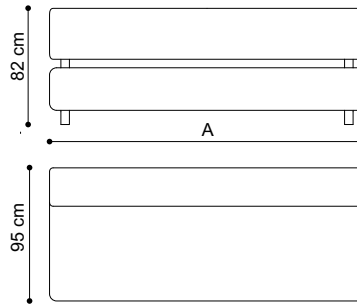

	A
3+ seater	222cm
3 seater	202cm
2 seater	142cm
1 seater	82cm

bench module

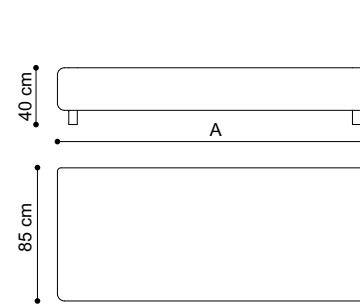

	A
3+ seater	222cm
3 seater	202cm
2 seater	142cm
1 seater	82cm

footstool module

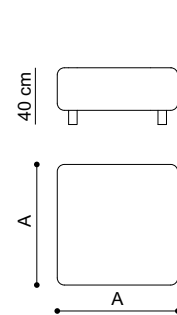

	A
small	120cm
medium	100cm
large	85cm

Description:

The “Cascada” sofa was inspired by pristine mountain waterfalls. The purpose of the design is to engage light and shadow in a never-ending game by providing an interesting playground of changing surfaces, volumes, voids, and materials. The sofa has several different modules and is suitable for reception areas and modern home interiors.

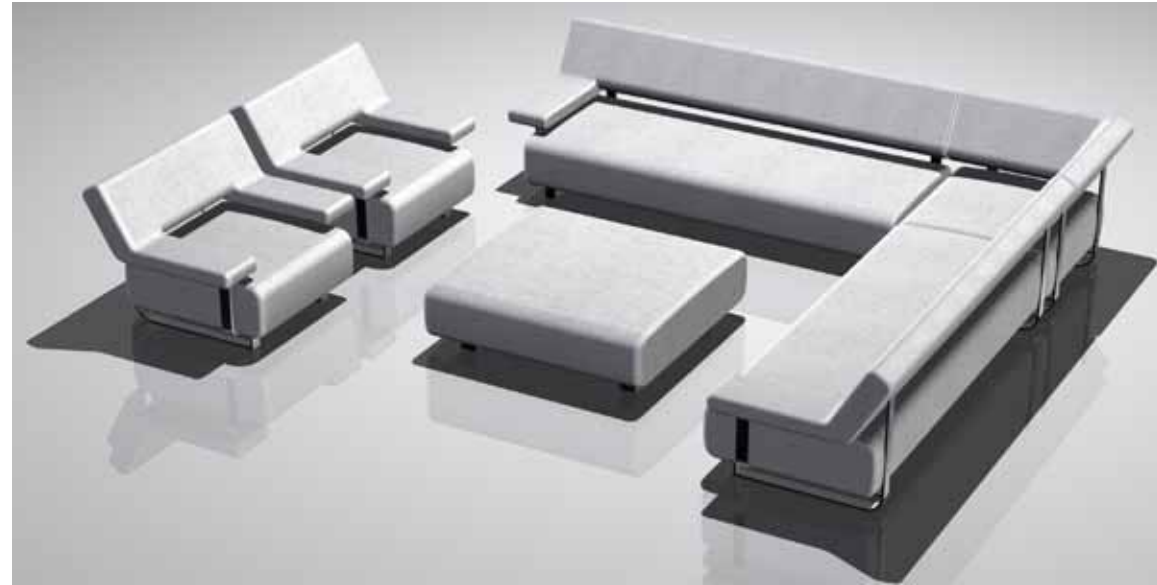

Key features:

- multipurpose armrests which can be used as extra seats or as tabletop surfaces
- removable upholstery covers on all modules
- improved seat ergonomics
- dismountable sofa modules – can be broken down into 6 basic components